

## PCB Relay

## G6M

### Slim, Miniature Relay, Capable of Relaying Programmable Controller and Temperature Controller Outputs

- Slim 5-mm width, and miniature size.
- Reduced bottom area ideal for high-density mounting.
- Highly efficient magnetic circuit for high sensitivity (40% higher than the G6D, with power consumption of 120 mW).
- Satisfies IEC61131-2 and IEC61010 requirements.
- SIL (single-in-line) terminal pitch.
- UL, CSA approved. VDE approval pending.

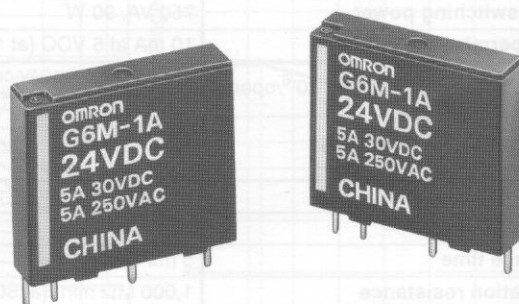

### Ordering Information

Classification	Contact form	Enclosure ratings	Model
Standard	SPST-NO	Fully sealed	G6M-1A

**Note:** When ordering, add the rated coil voltage to the model number.

Example: G6M-1A 12 VDC

Rated coil voltage

#### Model Number Legend

G6M -    VDC  
1 2 3

1. Number of Poles  
1: 1 pole
2. Contact Form  
A: SPST-NO
3. Rated Coil Voltage  
5, 12, 24 VDC

### Specifications

#### ■ Coil Ratings

Rated voltage	5 VDC	12 VDC	24 VDC
Rated current	24 mA	10 mA	5 mA
Coil resistance	208 Ω	1,200 Ω	4,800 Ω
Must operate voltage	70% max. of rated voltage		
Must release voltage	10% min. of rated voltage		
Max. voltage	160% of rated voltage (at 23°C)		
Power consumption	Approx. 120 mW		

- Note:**
1. The rated current and coil resistance are measured at a coil temperature of 23°C with a tolerance of ±10%.
  2. Operating characteristics are measured at a coil temperature of 23°C.
  3. The "Max. voltage" is the maximum voltage that can be applied to the relay coil. It is not the maximum voltage that can be applied continuously.
  4. The must operate voltage is 72% or less of the rated voltage if the relay is mounted vertically and the terminals are pointing downwards.

■ Contact Ratings

Rated load	3 A at 250 VAC, 3 A at 30 VDC
Rated carry current	5 A
Max. switching voltage	270 VAC, 125 VDC
Max. switching current	5 A
Max. switching power	750 VA, 90 W
Min. permissible load	10 mA at 5 VDC (at 120 operations/min)

Note: P level:  $\lambda_{60} = 0.1 \times 10^{-6}$ /operation

■ Characteristics

Contact resistance	100 mΩ max.
Operate time	10 ms max.
Release time	5 ms max.
Insulation resistance	1,000 MΩ min. (at 500 VDC)
Dielectric strength	3,000 VAC, 50/60 Hz for 1 min between coil and contacts 750 VAC, 50/60 Hz for 1 min between contacts of same polarity
Impulse withstand voltage	5,080 V (1.2 x 50 μs) between coil and contacts
Vibration resistance	Destruction: 10 to 55 Hz, 2.5-mm single amplitude (5.0-mm double amplitude) Malfunction: 10 to 55 Hz, 0.75-mm single amplitude (1.5-mm double amplitude)
Shock resistance	Destruction: 1,000 m/s <sup>2</sup> Malfunction: 100 m/s <sup>2</sup>
Endurance	Mechanical: 20,000,000 operations min. (at 18,000 operations/hr) Electrical: 100,000 operations min. (3 A at 250 VAC/30 VDC, resistive load)
Ambient temperature	Operating: -40°C to 85°C (with no icing)
Ambient humidity	Operating: 5% to 85%
Weight	Approx. 4 g

■ Approved Standards

UL508 (File No. E41515)/CSA C22.2 No.14 (File No. LR31928)

Model	Coil ratings	Contact ratings
G6M-1A	4.5 to 24 VDC	5 A, 250 VAC (resistive load, 6,000 operations) 5 A, 24 VDC (resistive load, 6,000 operations) 3 A, 250 VAC (general use, 100,000 operations) 3A, 24 VDC (general use, 100,000 operations)

Rated voltage	Rated current	Coil resistance	Must operate voltage	Must release voltage	Max. voltage	Power consumption
24 VDC	5 A	1,500 Ω	10% max. of rated voltage	10% min. of rated voltage	150% of rated voltage (at 23°C)	Approx. 150 mW
12 VDC	10 mA	1,500 Ω	10% max. of rated voltage	10% min. of rated voltage	150% of rated voltage (at 23°C)	Approx. 150 mW
5 VDC	5 A	1,500 Ω	10% max. of rated voltage	10% min. of rated voltage	150% of rated voltage (at 23°C)	Approx. 150 mW

Note: 1. The rated current and coil resistance are measured at a coil temperature of 23°C with a tolerance of ±10%.  
2. Operating characteristics are measured at a coil temperature of 23°C.  
3. The "max. voltage" is the maximum voltage that can be applied to the relay coil. It is not the maximum voltage that can be applied continuously.  
4. The "must operate voltage" is 75% or less of the rated voltage if the relay is mounted vertically and the terminals are pointing downwards.

# Engineering Data

## Maximum Switching Power

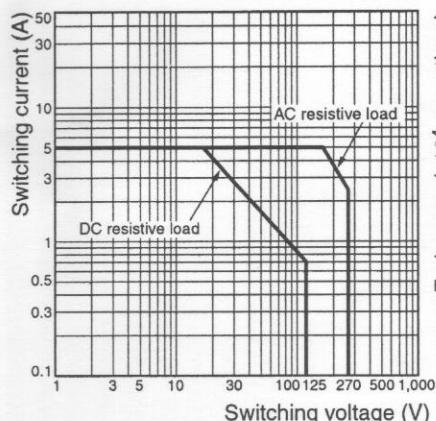

## Endurance

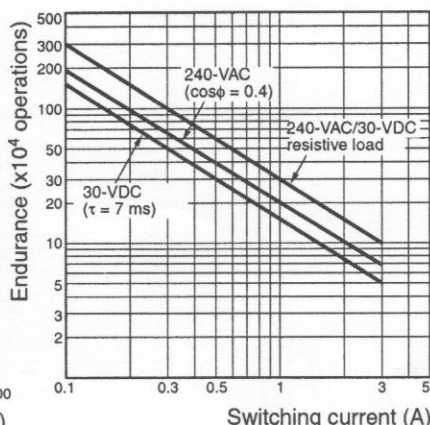

## Ambient Temperature vs. Maximum Coil Voltage

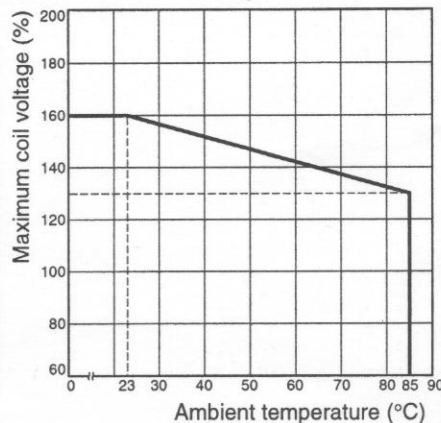

Note: The maximum coil voltage refers to the maximum value in a varying range of operating power voltage, not a continuous voltage.

# Dimensions

## G6M-1A

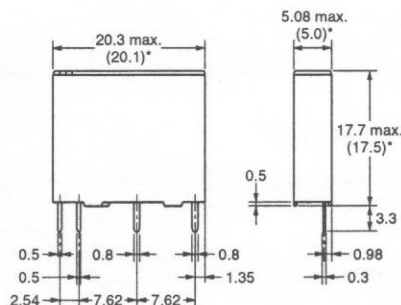
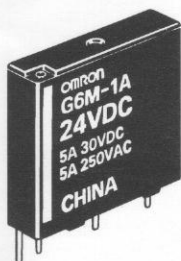

## Terminal Arrangement/ Internal Connections (Bottom View)

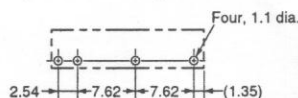

## Mounting Holes (Bottom View)

Tolerance:  $\pm 0.1$

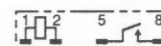

\*Average value

# Precautions

## Basic Information

Before actually committing any component to a mass-production situation, OMRON strongly recommends situational testing, in as close to actual production situations as possible. One reason is to confirm that the product will still perform as expected after surviving the many handling and mounting processes involved in mass production. Also, even though OMRON relays are individually tested a number of times, and each meets strict requirements, a certain testing tolerance is permissible. When a high-precision product uses many components, each depends upon the rated performance thresholds of the other components. Thus, the overall performance tolerance may accumulate into undesirable levels. To avoid problems, always conduct tests under the actual application conditions.

## General

To maintain the initial characteristics of a relay, exercise care that it is not dropped or mishandled. For the same reason, do not remove the case of the relay; otherwise, the characteristics may degrade. Avoid using the relay in an atmosphere containing sulfuric acid ( $SO_2$ ), hydrogen sulfide ( $H_2S$ ), or other corrosive gases. Do not continuously apply a voltage higher than the rated maximum voltage to the relay. Never try to operate the relay at a voltage and a current other than those rated. Do not use the relay at temperatures higher than that specified in the catalog or data sheet.

Printed in Japan  
5002-1M (0202) (B)

OMRON Corporation  
Electronic Components Company  
G&C Components Division, P.O.  
Shin-oh, Hokkaido, Shimodaira-ku  
Kyofo, 650-8530 Japan  
Tel: (81)75-344-7027 Fax: (81)75-344-7048